

NL17SZ06

Single Inverter with Open Drain Outputs

The NL17SZ06 is a high performance single inverter with open drain outputs operating from a 1.65 to 5.5 V supply.

The Output stage is open drain with Over Voltage Tolerance. This allows the NL17SZ06 to be used to interface 5.0 V circuits to circuits of any voltage between 0 and +7.0 V.

Features

- Tiny SOT-353 and SOT-553 Packages
- Extremely High Speed: t_{PD} 2.5 ns (typical) at $V_{CC} = 5.0$ V
- Designed for 1.65 V to 5.5 V V_{CC} Operation, CMOS Compatible
- Over Voltage Tolerant Inputs V_{IN} may be Between 0 and 7.0 V for V_{CC} Between 0.5 and 5.4 V
- TTL Compatible – Interface Capability with 5.0 V TTL Logic with $V_{CC} = 2.7$ V to 3.6 V
- LVC MOS Compatible
- 24 mA Output Sink Capability, Pullup may be between 0 and 7.0 V
- Near Zero Static Supply Current Substantially Reduces System Power Requirements
- Chip Complexity: FET = 20
- Pb-Free Packages are Available

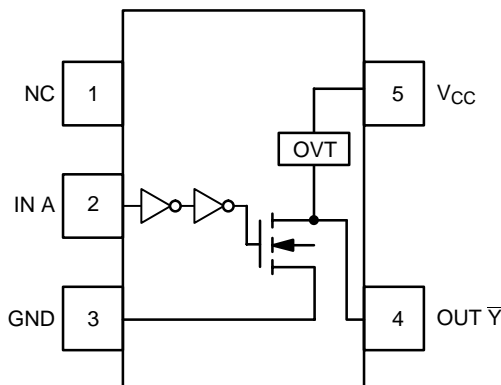

Figure 1. Pinout (Top View)

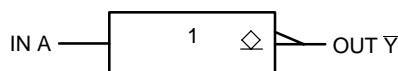

Figure 2. Logic Symbol



ON Semiconductor®

<http://onsemi.com>

MARKING DIAGRAMS

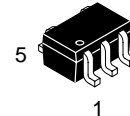

SOT-353/SC70-5/SC-88A
DF SUFFIX
CASE 419A

d = Date Code

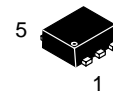
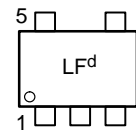

SOT-553
XV5 SUFFIX
CASE 463B

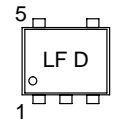

LF = Device Marking
D = One Digit Date Code

PIN ASSIGNMENT

| Pin | Function |
|-----|---------------|
| 1 | NC |
| 2 | IN A |
| 3 | GND |
| 4 | OUT \bar{Y} |
| 5 | V_{CC} |

FUNCTION TABLE

| A Input | \bar{Y} Output |
|---------|------------------|
| L | Z |
| H | L |

ORDERING INFORMATION

See detailed ordering and shipping information in the package dimensions section on page 4 of this data sheet.

NL17SZ06

MAXIMUM RATINGS

| Symbol | Characteristics | Value | Unit |
|-----------------------|--|------------------------------|------|
| V _{CC} | DC Supply Voltage | -0.5 to +7.0 | V |
| V _I | DC Input Voltage | -0.5 ≤ V _I ≤ +7.0 | V |
| V _O | DC Output Voltage Output in Z or LOW State (Note 1) | -0.5 ≤ V _O ≤ 7.0 | V |
| I _{IK} | DC Input Diode Current V _I < GND | -50 | mA |
| I _{OK} | DC Output Diode Current V _O < GND | -50 | mA |
| I _O | DC Output Sink Current | ±50 | mA |
| I _{CC} | DC Supply Current Per Supply Pin | ±100 | mA |
| I _{GND} | DC Ground Current Per Ground Pin | ±100 | mA |
| T _{STG} | Storage Temperature Range | -65 to +150 | °C |
| P _D | Power Dissipation in Still Air SOT-353 SOT-553 | 186 135 | mW |
| θ _{JA} | Thermal Resistance SOT-353 SOT-553 | 350 496 | °C/W |
| T _L | Lead Temperature, 1 mm from Case for 10 Seconds | 260 | °C |
| T _J | Junction Temperature Under Bias | +150 | °C |
| I _{Latch-Up} | Latchup Performance Above V _{CC} and Below GND at 85°C (Note 5) | ±500 | mA |
| MSL | Moisture Sensitivity | Level 1 | |
| F _R | Flammability Rating Oxygen Index: 28 to 34 | UL 94 V-0 @ 0.125 in | |
| ESD | ESD Classification Human Body Model (Note 3) Machine Model (Note 4) Charged Device Model (Note 5) | Class IC Class A N/A | |

Maximum ratings are those values beyond which device damage can occur. Maximum ratings applied to the device are individual stress limit values (not normal operating conditions) and are not valid simultaneously. If these limits are exceeded, device functional operation is not implied, damage may occur and reliability may be affected.

1. I_O absolute maximum rating must be observed.
2. Tested to EIA/JESD22-A114-A, rated to EIA/JESD22-A114-B.
3. Tested to EIA/JESD22-A115-A, rated to EIA/JESD22-A115-A.
4. Tested to JESD22-C101-A.
5. Tested to EIA/JESD78.

RECOMMENDED OPERATING CONDITIONS

| Symbol | Parameter | Min | Max | Unit |
|-----------------|--|-------------|---------------|------|
| V _{CC} | Supply Voltage Operating Data Retention Only | 1.65 1.5 | 5.5 5.5 | V |
| V _I | Input Voltage | 0 | 5.5 | V |
| V _O | Output Voltage (Z or LOW State) | 0 | 5.5 | V |
| T _A | Operating Free-Air Temperature | -40 | +85 | °C |
| Δt/ΔV | Input Transition Rise or Fall Rate V _{CC} = 2.5 V ±0.2 V V _{CC} = 3.0 V ±0.3 V V _{CC} = 5.0 V ±0.5 V | 0 0 0 | 20 10 5 | ns/V |

NL17SZ06

DC ELECTRICAL CHARACTERISTICS

| Symbol | Parameter | Condition | V _{CC} (V) | T _A = 25°C | | | -40°C ≤ T _A ≤ 85°C | | Unit |
|------------------|--|--|----------------------------|---|------|---|---|---|------|
| | | | | Min | Typ | Max | Min | Max | |
| V _{IH} | High-Level Input Voltage | | 1.65 to 1.95 2.3 to 5.5 | 0.75 V _{CC} 0.7 V _{CC} | | | 0.75 V _{CC} 0.7 V _{CC} | | V |
| V _{IL} | Low-Level Input Voltage | | 1.65 to 1.95 2.3 to 5.5 | | | 0.25 V _{CC} 0.3 V _{CC} | | 0.25 V _{CC} 0.3 V _{CC} | V |
| I _{LKG} | Z-State Output Leakage Current | V _{IN} = V _{IL} V _{OUT} = V _{CC} or GND | 2.3 to 5.5 | | | ± 5.0 | | ± 10.0 | μA |
| V _{OL} | Low-Level Output Voltage V _{IN} = V _{IH} or V _{IL} | I _{OL} = 100 μA | 1.65 to 5.5 | | 0.0 | 0.1 | | 0.1 | V |
| | | I _{OL} = 4 mA | 1.65 | | 0.08 | 0.24 | | 0.24 | |
| | | I _{OL} = 8 mA | 2.3 | | 0.22 | 0.3 | | 0.3 | |
| | | I _{OL} = 12 mA | 2.7 | | 0.22 | 0.4 | | 0.4 | |
| | | I _{OL} = 16 mA | 3.0 | | 0.28 | 0.4 | | 0.4 | |
| | | I _{OL} = 24 mA | 3.0 | | 0.38 | 0.55 | | 0.55 | |
| | | I _{OL} = 32 mA | 4.5 | | 0.42 | 0.55 | | 0.55 | |
| I _{IN} | Input Leakage Current | V _{IN} or V _{OUT} = V _{CC} or GND | 0 to 5.5 | | | ± 0.1 | | ± 1.0 | μA |
| I _{OFF} | Power Off-Output Leakage Current | V _{OUT} = 5.5 V | 0 | | | 1.0 | | 10 | μA |
| I _{CC} | Quiescent Supply Current | V _{IN} = V _{CC} or GND | 5.5 | | | 1.0 | | 10 | μA |

AC ELECTRICAL CHARACTERISTICS t_R = t_F = 2.5 ns; C_L = 50 pF; R_L = 500 Ω

| Symbol | Parameter | Condition | V _{CC} (V) | T _A = 25°C | | | -40°C ≤ T _A ≤ 85°C | | Unit |
|------------------|---------------------------------------|---|---------------------|-----------------------|-----|------|-------------------------------|------|------|
| | | | | Min | Typ | Max | Min | Max | |
| t _{PZL} | Propagation Delay (Figure 3 and 4) | R _L = R ₁ = 500 Ω, C _L = 50 pF | 1.65 | 0.8 | 5.3 | 11.6 | 0.8 | 12.0 | ns |
| | | | 2.5 ± 0.2 | 0.8 | 3.0 | 3.6 | 0.8 | 4.1 | |
| | | | 3.3 ± 0.3 | 0.8 | 2.4 | 3.2 | 0.8 | 3.7 | |
| | | | 5.0 ± 0.5 | 0.5 | 2.4 | 3.0 | 0.5 | 3.5 | |
| t _{PLZ} | Propagation Delay (Figure 3 and 4) | R _L = R ₁ = 500 Ω, C _L = 50 pF | 1.65 | 0.8 | 5.3 | 11.6 | 0.8 | 12.0 | ns |
| | | | 2.5 ± 0.2 | 0.8 | 2.5 | 3.6 | 0.8 | 4.1 | |
| | | | 3.3 ± 0.3 | 0.8 | 2.1 | 3.2 | 0.8 | 3.7 | |
| | | | 5.0 ± 0.5 | 0.5 | 1.2 | 3.0 | 0.5 | 3.5 | |

CAPACITIVE CHARACTERISTICS

| Symbol | Parameter | Condition | Typical | Unit |
|------------------|--|--|---------|------|
| C _{IN} | Input Capacitance | V _{CC} = 5.5 V, V _I = 0 V or V _{CC} | > 2.5 | pF |
| C _{OUT} | Output Capacitance | V _{CC} = 5.5 V, V _I = 0 V or V _{CC} | 4.0 | pF |
| C _{PD} | Power Dissipation Capacitance (Note 6) | 10 MHz, V _{CC} = 5.5 V, V _I = 0 V or V _{CC} | 4.0 | pF |

6. C_{PD} is defined as the value of the internal equivalent capacitance which is calculated from the operating current consumption without load. Average operating current can be obtained by the equation: I_{CC(OPR)} = C_{PD} • V_{CC} • f_{in} + I_{CC}. C_{PD} is used to determine the no-load dynamic power consumption; P_D = C_{PD} • V_{CC}² • f_{in} + I_{CC} • V_{CC}.

NL17SZ06

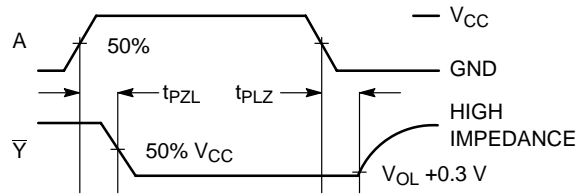
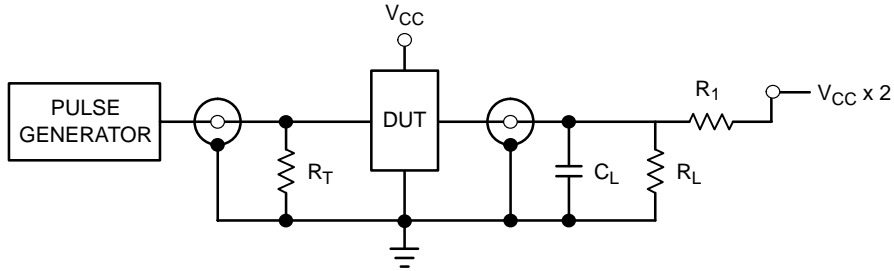

Figure 3. Switching Waveforms



$R_T = Z_{OUT}$ of pulse generator (typically 50 Ω)

Figure 4. Test Circuit

DEVICE ORDERING INFORMATION

| Device Order Number | Device Nomenclature | | | | | | | Package Type | Tape and Reel Size† |
|---------------------|-------------------------|--------------------------|-----------------------|------------|-----------------|----------------|--------------------|--|--------------------------|
| | Logic Circuit Indicator | No. of Gates per Package | Temp Range Identifier | Technology | Device Function | Package Suffix | Tape & Reel Suffix | | |
| NL17SZ06DFT2 | NL | 1 | 7 | SZ | 06 | DF | T2 | SOT-353/ SC70-5/ SC-88A | 178 mm (7") 3000 Unit |
| NL17SZ06DFT2G | NL | 1 | 7 | SZ | 06 | DF | T2 | SOT-353/ SC70-5/ SC-88A (Pb-Free) | 178 mm (7") 3000 Unit |
| NL17SZ06XV5T2 | NL | 1 | 7 | SZ | 06 | XV5 | T2 | SOT-553* | 178 mm (7") 4000 Unit |

†For information on tape and reel specifications, including part orientation and tape sizes, please refer to our Tape and Reel Packaging Specifications Brochure, BRD8011/D.

*All Devices in Package SOT553 are Inherently Pb-Free.

NL17SZ06

PACKAGE DIMENSIONS

SOT-353
DF SUFFIX
5-LEAD PACKAGE
CASE 419A-02
ISSUE G

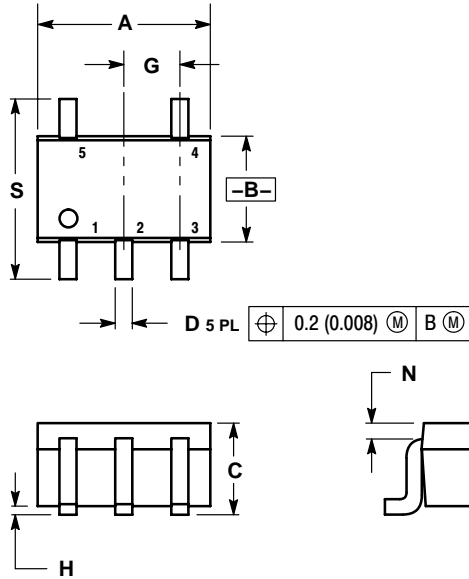

NOTES:

1. DIMENSIONING AND TOLERANCING PER ANSI Y14.5M, 1982.
2. CONTROLLING DIMENSION: INCH.
3. 419A-01 OBSOLETE. NEW STANDARD 419A-02.
4. DIMENSIONS A AND B DO NOT INCLUDE MOLD FLASH, PROTRUSIONS, OR GATE BURRS.

| DIM | INCHES | | MILLIMETERS | |
|-----|-----------|-------|-------------|------|
| | MIN | MAX | MIN | MAX |
| A | 0.071 | 0.087 | 1.80 | 2.20 |
| B | 0.045 | 0.053 | 1.15 | 1.35 |
| C | 0.031 | 0.043 | 0.80 | 1.10 |
| D | 0.004 | 0.012 | 0.10 | 0.30 |
| G | 0.026 BSC | | 0.65 BSC | |
| H | --- | 0.004 | --- | 0.10 |
| J | 0.004 | 0.010 | 0.10 | 0.25 |
| K | 0.004 | 0.012 | 0.10 | 0.30 |
| N | 0.008 REF | | 0.20 REF | |
| S | 0.079 | 0.087 | 2.00 | 2.20 |

SOLDERING FOOTPRINT*

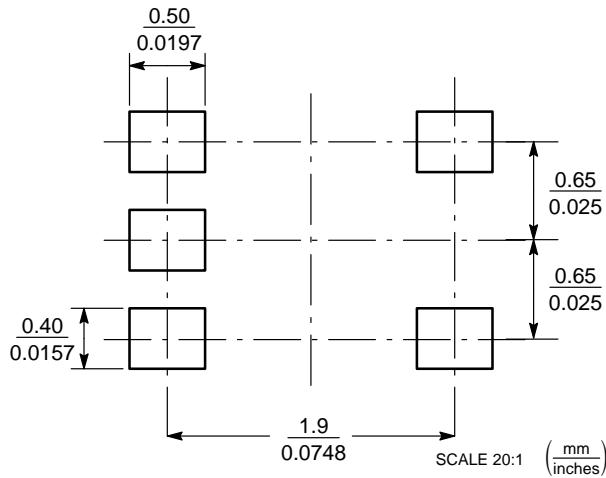

*For additional information on our Pb-Free strategy and soldering details, please download the ON Semiconductor Soldering and Mounting Techniques Reference Manual, SOLDERRM/D.

NL17SZ06

PACKAGE DIMENSIONS

SOT-553
XV5 SUFFIX
5-LEAD PACKAGE
CASE 463B-01
ISSUE A

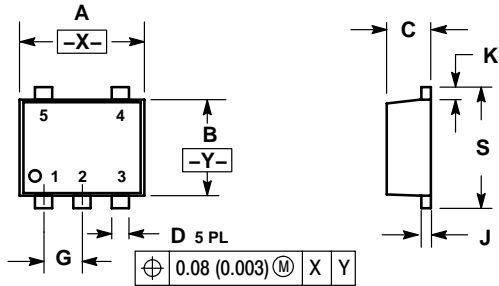

NOTES:

1. DIMENSIONING AND TOLERANCING PER ANSI Y14.5M, 1982.
2. CONTROLLING DIMENSION: MILLIMETERS
3. MAXIMUM LEAD THICKNESS INCLUDES LEAD FINISH THICKNESS. MINIMUM LEAD THICKNESS IS THE MINIMUM THICKNESS OF BASE MATERIAL.

| DIM | MILLIMETERS | | INCHES | |
|-----|-------------|------|-----------|-------|
| | MIN | MAX | MIN | MAX |
| A | 1.50 | 1.70 | 0.059 | 0.067 |
| B | 1.10 | 1.30 | 0.043 | 0.051 |
| C | 0.50 | 0.60 | 0.020 | 0.024 |
| D | 0.17 | 0.27 | 0.007 | 0.011 |
| G | 0.50 BSC | | 0.020 BSC | |
| J | 0.08 | 0.18 | 0.003 | 0.007 |
| K | 0.10 | 0.30 | 0.004 | 0.012 |
| S | 1.50 | 1.70 | 0.059 | 0.067 |

STYLE 1:
 PIN 1. BASE 1
 2. EMITTER 1/2
 3. BASE 2
 4. COLLECTOR 2
 5. COLLECTOR 1

STYLE 2:
 PIN 1. CATHODE
 2. ANODE
 3. CATHODE
 4. CATHODE
 5. CATHODE

SOLDERING FOOTPRINT*

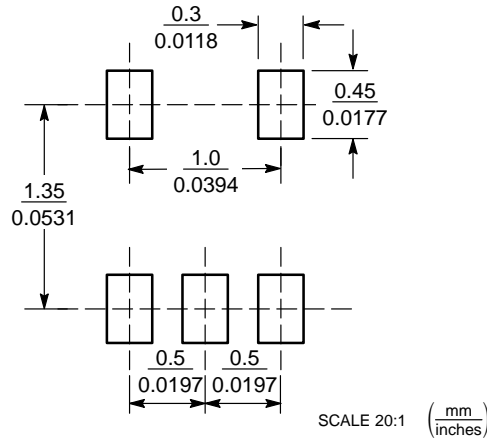

*For additional information on our Pb-Free strategy and soldering details, please download the ON Semiconductor Soldering and Mounting Techniques Reference Manual, SOLDERRM/D.

ON Semiconductor and are registered trademarks of Semiconductor Components Industries, LLC (SCILLC). SCILLC reserves the right to make changes without further notice to any products herein. SCILLC makes no warranty, representation or guarantee regarding the suitability of its products for any particular purpose, nor does SCILLC assume any liability arising out of the application or use of any product or circuit, and specifically disclaims any and all liability, including without limitation special, consequential or incidental damages. "Typical" parameters which may be provided in SCILLC data sheets and/or specifications can and do vary in different applications and actual performance may vary over time. All operating parameters, including "Typicals" must be validated for each customer application by customer's technical experts. SCILLC does not convey any license under its patent rights nor the rights of others. SCILLC products are not designed, intended, or authorized for use as components in systems intended for surgical implant into the body, or other applications intended to support or sustain life, or for any other application in which the failure of the SCILLC product could create a situation where personal injury or death may occur. Should Buyer purchase or use SCILLC products for any such unintended or unauthorized application, Buyer shall indemnify and hold SCILLC and its officers, employees, subsidiaries, affiliates, and distributors harmless against all claims, costs, damages, and expenses, and reasonable attorney fees arising out of, directly or indirectly, any claim of personal injury or death associated with such unintended or unauthorized use, even if such claim alleges that SCILLC was negligent regarding the design or manufacture of the part. SCILLC is an Equal Opportunity/Affirmative Action Employer. This literature is subject to all applicable copyright laws and is not for resale in any manner.

PUBLICATION ORDERING INFORMATION

LITERATURE FULFILLMENT:
 Literature Distribution Center for ON Semiconductor
 P.O. Box 611312, Phoenix, Arizona 85082-1312 USA
Phone: 480-829-7710 or 800-344-3860 Toll Free USA/Canada
Fax: 480-829-7709 or 800-344-3867 Toll Free USA/Canada
Email: orderlit@onsemi.com

N. American Technical Support: 800-282-9855 Toll Free USA/Canada
Japan: ON Semiconductor, Japan Customer Focus Center
 2-9-1 Kamimeguro, Meguro-ku, Tokyo, Japan 153-0051
Phone: 81-3-5773-3850

ON Semiconductor Website: <http://onsemi.com>
Order Literature: <http://www.onsemi.com/litorder>
 For additional information, please contact your local Sales Representative.